

Article number: 203380M16177B1W

Description: E+G levelling foot
GN 33-80-M16-177-B1-W, Stainless steel

Note: W With adjustable sleeve , Hygienic Version, Wrench flat at the bottom

Measures

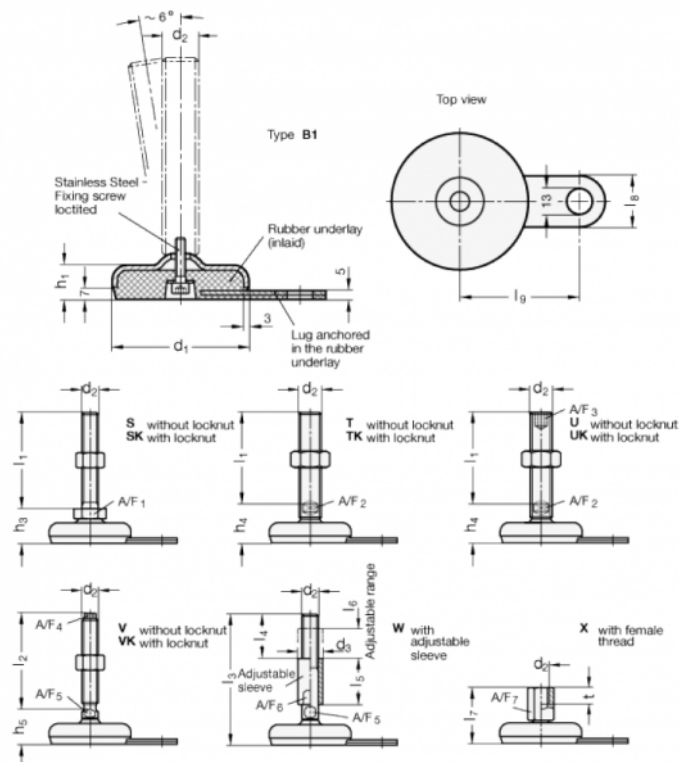

A/F5 = 12	I5 = 45
A/F6 = 20	I6 = 29
d1 = 80	I8 = 30
d2 = M16	I9 = 70
d3 = 24	
h1 = 20	
h2 = 45	
I3 = 177	